



### General

- Fast acting
- 1.0mm× 0.5mm physical size
- Thick film manufacturing method, ceramic substrate, silver fusing element
- -55℃~125℃ operating temperature
- Excellent environmental integrity
- RoHS compliant
- Halogen-free
- Lead free

### Agency / Certificate Information

Agency	File Number	Ampere Range
	E319512	1.0A~5.0A

### Application

- Smart wearable systems
- Battery pack
- PC related equipment and peripherals (Hard driver, Printer, etc.)
- Digital camera (Digital still camera)
- Game equipment
- LCD monitor, LCD modules
- Medical device

### Electrical Specifications

Part Number	Current Rating (A)	Voltage Rating (V)	Interrupting Rating (V)	Typical Cold DCR* (mΩ)	Typical I <sup>2</sup> T** (A <sup>2</sup> sec)
S0402-F-1.0A	1.0	32	35A 32V DC	145.0	0.030
S0402-F-1.5A	1.5	32		75.0	0.061
S0402-F-2.0A	2.0	32		33.7	0.078
S0402-F-2.5A	2.5	32		24.3	0.186
S0402-F-3.0A	3.0	32		25.3	0.205
S0402-F-3.5A	3.5	32		23.2	0.196
S0402-F-4.0A	4.0	32		16.5	0.341
S0402-F-5.0A	5.0	32		12.0	0.745

\* Measured at ≤10% rated current and 25℃

\*\* Melting I<sup>2</sup>T at 10 times of rated current

### Part Number Information

S 0402-F-1.0A

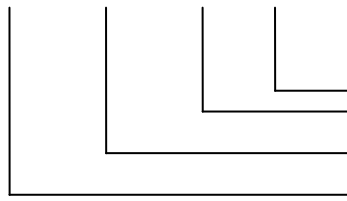

- "1.0A" Ampere Rating: 1A
- "F" Electrical Characteristic: F = Fast acting
- "0402" Size Number
- "S" Symbol of SART

### Dimensions

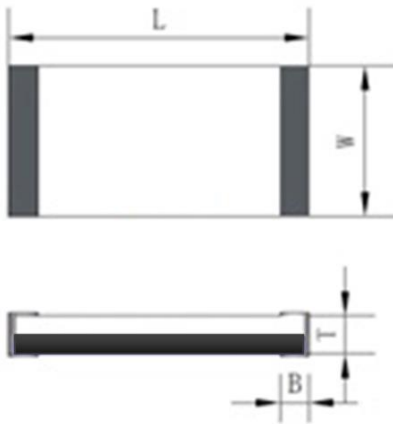

Type	L (mm)	W (mm)	T (mm)	B (mm)
S0402-F	0.95±0.15	0.50±0.10	0.28±0.10	0.20±0.10

### Recommended Land Patterns

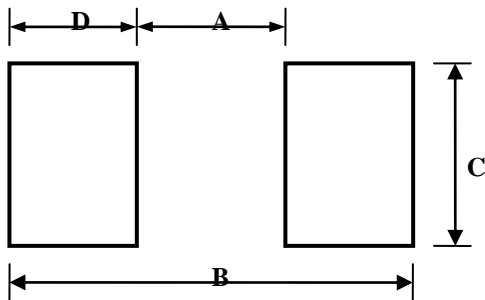

Type	A(mm)	B(mm)	C(mm)	D(mm)
S0402-F	0.50±0.10	1.50±0.10	0.75±0.10	0.50±0.10

### Materials

Components	Material
Body	Ceramic
Terminations	Silver over plated with tin (100%)
Element	Silver or Silver/Palladium

### Dimensions of Standard Test Board

Type	Ampere Rating	Board Thickness (mm)	Copper Layer Thickness (mm)	Copper Trace Width (mm)
S0402-F	1.0A~2.5A	1.6	0.035	1.0
	3.0A~5.0A	1.6	0.035	5.0

**Time Current Curve**

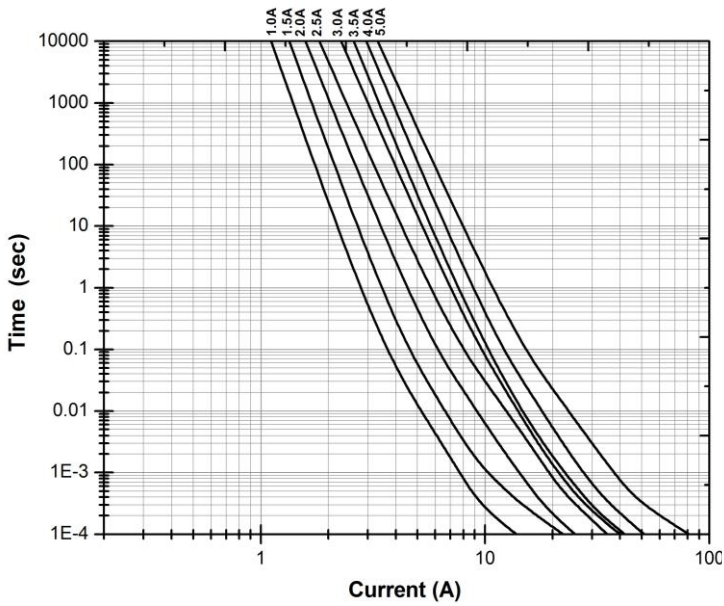

**$I^2T$  VS Time Curve**

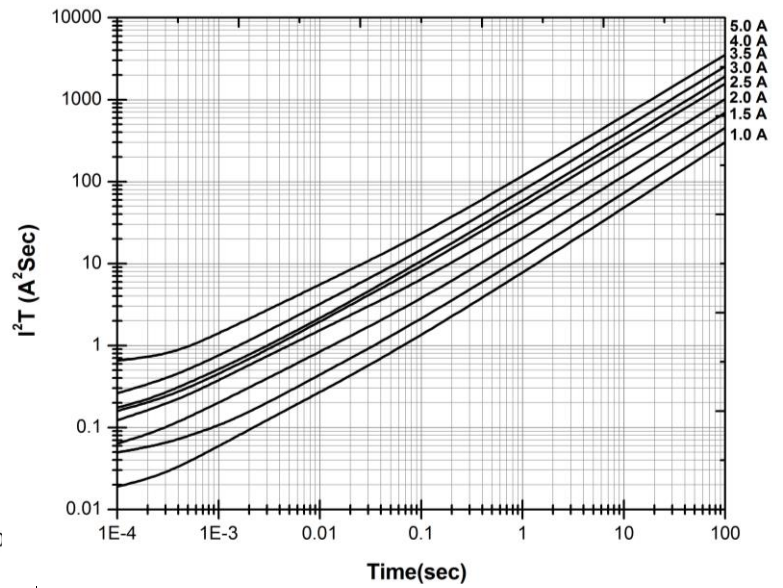

**Electrical Characteristics**

Type	Ampere Rating	% of Current Rating	Opening Time
S0402-F	1.0A~5.0A	100	4hours Min.
		250	5sec Max.
		1000	0.1msec Min.

**Temperature Derating Curve**

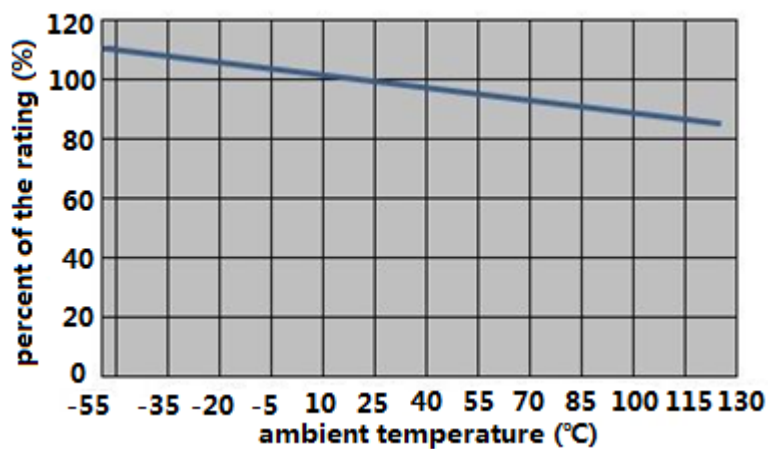

## Product Characteristics

Item	Test condition/ Methods	Performance	Standard
Time/Current	100% of current rating	No Fusing, 4hours Min.	UL248-14
	250% of current rating	≤5sec	SART SPEC.
	1000% of current rating	>0.1msec	
Voltage Drop	100% of current rating	<300mV	IEC60127-4
Temperature Rise	100% of current rating	ΔT<75℃	UL248-14
Endurance Test	100 cycles of 1In for 1h "ON", for 15min "OFF", then following by 1h at 125%In	ΔR :<10%	IEC60127-4
Interrupting Ability	35A 32V DC	without permanent arcing, ignition and bursting of fuse link	UL248-14 IEC60127-4
Solderability	240℃±5℃, 3sec±0.5sec	95% coverage Min.	IEC60127-4 MIL-STD-202 Method 208
Resistance to Soldering	260℃±5℃, 10sec±0.5sec	ΔR :<10% Legible appearance	MIL-STD-202 Method 210
Bending Test	Distance between holding points: 90mm Bending: 1mm, time: 10sec	ΔR :<10% No mechanical damages	IEC60127-4
High Temperature Operating Life	T=70℃±2℃, 60%In, 96hours	ΔR : <10%; No fusing	MIL-STD-202 Method 108
Humidity (Steady State)	T=40℃±2℃, 90%~95%RH, 1000hours	ΔR : <10%	MIL-STD-202 Method 103
Low Temperature Storage	T=-55℃±3℃, 96hours	ΔR : <10%	IEC60068-2-1
High Temperature Storage	T=125℃±2℃, 96hours	ΔR : <10%	IEC60068-2-2
Salt Spray	5% salt solution, 48hours	ΔR : <10% Legible appearance	MIL-STD-202 Method 101
Thermal Shock	100 cycles between -65℃/+125℃ 60 minutes, each extreme	ΔR : <10% No mechanical damages	MIL-STD-202 Method 107

## Recommended Solder Curve

### 1. Infrared Reflow:

- Temperature: 260°C
- Time: 20sec Max.
- Recommend Reflow profile

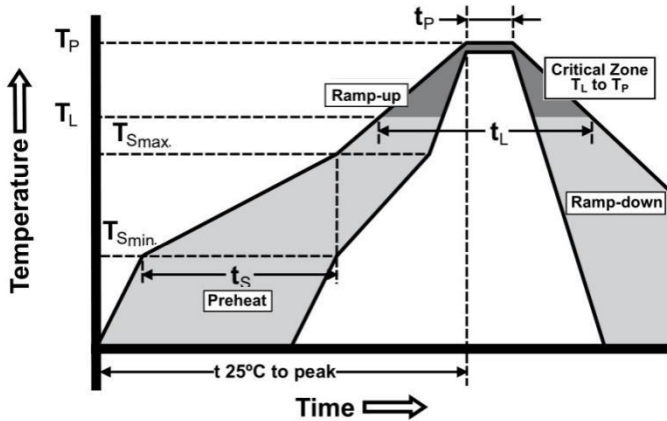

Profile Feature	Pb-Free Assembly
Average Ramp-up Rate( $T_{Smax}$ to $T_p$ )	3°C/sec Max.
Preheat Temperature Min. ( $T_{Smin}$ )	150°C
Temperature Max. ( $T_{Smax}$ )	200°C
Time ( $T_{Smin}$ to $T_{Smax}$ )	60sec~120sec
Peak Temperature ( $T_p$ )	260°C
Time within 5°C of actual Peak Temperature ( $t_p$ )	20sec
Melting tin time ( $t_L$ )	60sec~150sec
Ramp-down Rate	6°C/sec Max.
Time 25°C to peak Temperature	8minutes Max.

### 2. Wave soldering

- Reservoir Temperature: 260°C
- Time in Reservoir: 10secMax.

### 3. Hand Soldering

- Temperature: 350°C
- Time: 5secMax.

## Packaging

- 10000 pieces of fuses in emboss taper and reeled on a 178mm(7 inch) reel.

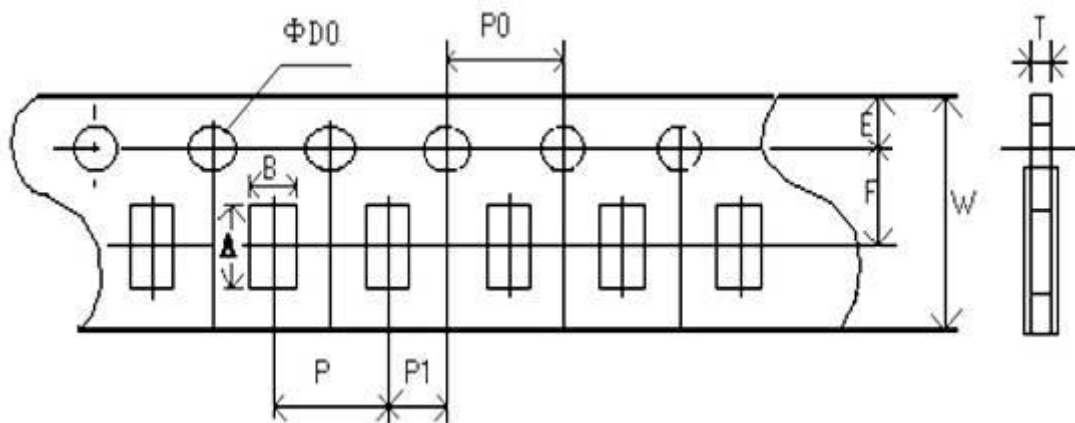

Type	A(mm)	B(mm)	W(mm)	E(mm)	F(mm)
S0402-F	1.20±0.10	0.70±0.10	8.00±0.20	1.75±0.10	3.50±0.05
Type	P(mm)	P0(mm)	P1(mm)	D0(mm)	T(mm)
S0402-F	2.00±0.05	4.00±0.10	2.00±0.05	1.50±0.10	0.42±0.10



Type	M(mm)	W(mm)	T(mm)	A(mm)	B(mm)	C(mm)	D(mm)
S0402-F	178.00±2.00	12.50±1.00	14.50±1.50	2.00±0.50	13.00±0.50	21.00±0.50	58.00±2.00

### Storage

- The ambient temperature recommended for storage shall be between 5°C~30°C
- The relative humidity recommended for storage shall be between 25%RH~60%RH
- Sealed plastic bags with desiccant shall be used to reduce the oxidation of the termination and shall only be opened prior to use
- The products shall not be stored in areas where harmful gases containing sulfur or chlorine are present